

PONTOS DE OPERAÇÃO

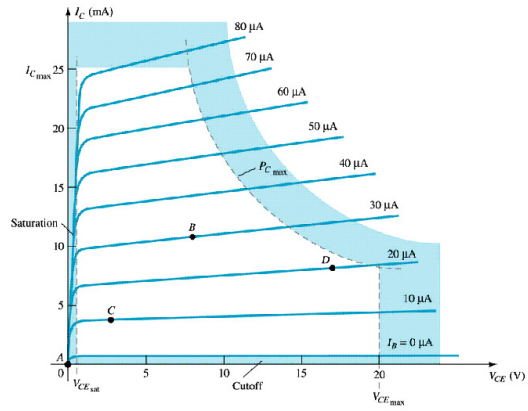

RETA DE CARGA

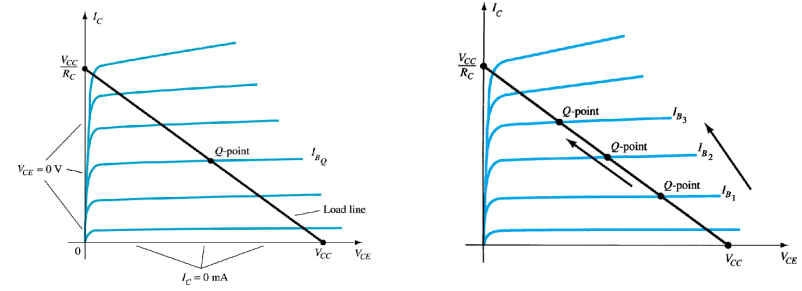

RETA DE CARGA

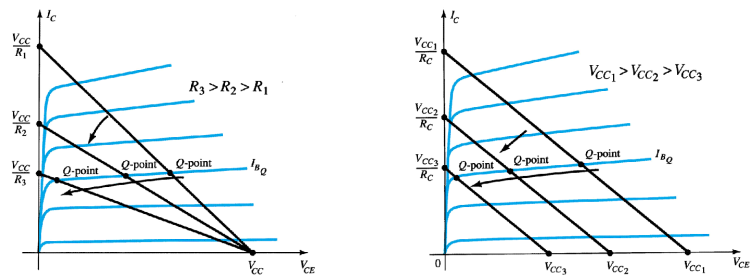

EXEMPLO

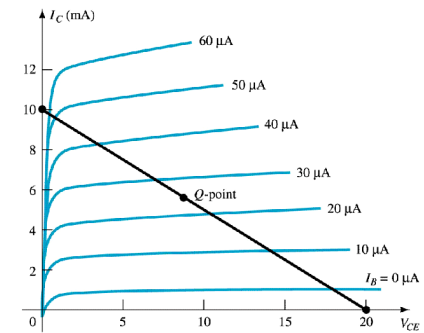

POLARIZAÇÃO ESTÁVEL

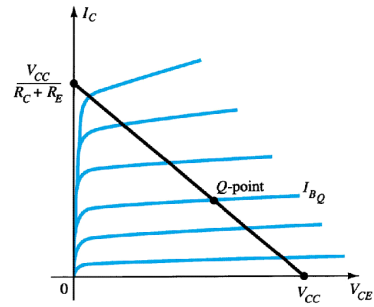

5

POLARIZAÇÃO POR DIVISÃO DE TENSÃO

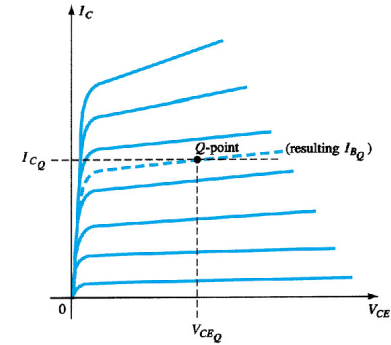

6

CHAVEAMENTO COM TRANSISTOR

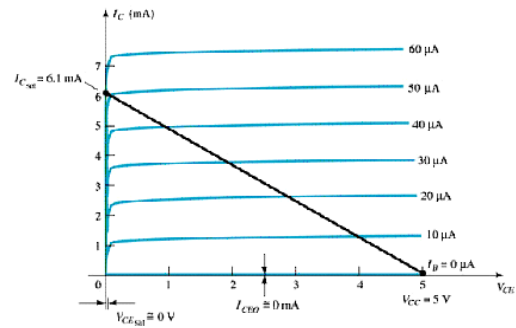

7

PORTAS LÓGICAS

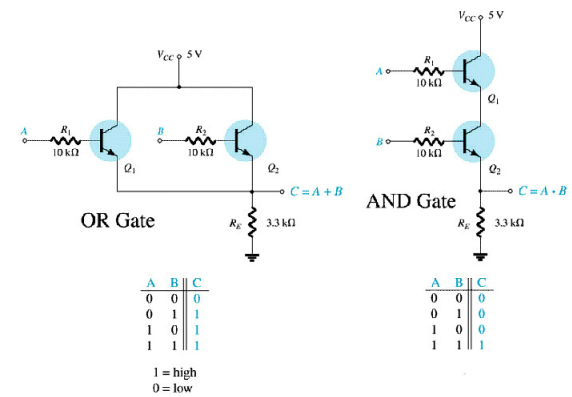

8